

The ability to connect the sampler close to the sample point, by means of an anti static, fire safe process ball valve with reduced bore and equipped with a spring return handle, ensures optimal retrieval of a representative, contamination free sample. The HD type sampler in on/off configuration allows product to flow directly into the sampler via a two way valve.

1 OPERATION/FUNCTION

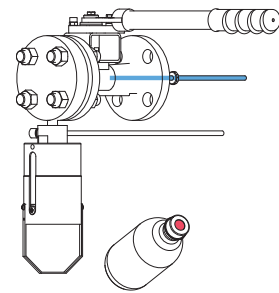

0 - off
Provide a new septum on your sample bottle. Insert the bottle, with cap and septum into the sleeve until the septum is pierced by the needles. Put the bottle retaining clip in place.

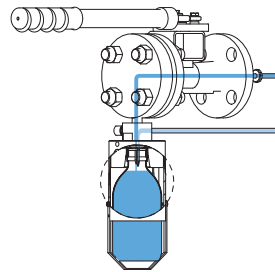

1 - sample
Pull the handle to the "sample" position, allowing the product to flow into the sample bottle. When the required amount has been taken, release the handle. The valve will close automatically.

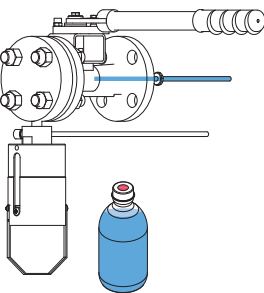

2 - off
Remove the bottle retaining clip and pull the bottle out from the sleeve. The septum reseals automatically.

2 TYPICAL P & ID

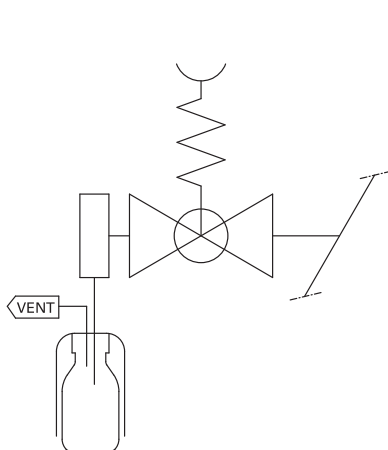

On / off (B1)

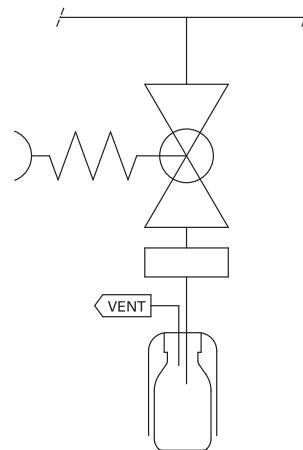

On / off (B2)



3 FEATURES/ADVANTAGES/PROPERTIES

- Sampling directly under process conditions
- Low pressure application
- Representative sampling
- Minimal dead volume
- Closed sampling
- Anti static and fire safe process valve

4 BASIC SPECIFICATIONS

Material	SS316, SS316L.	
Sleeve type	60cc sleeve with bottle retaining clip.	
Needle assembly	Single piece VTO needle assembly with vent to outlet connection 1/4" FNPT. Process/vent needle ID: 1.35 mm.	
Valve	Straight ball valve. PTFE seats. Fire safe, anti static. Pressure range 19 bar @ 20°C (275 psig @ 68°F). Temperature range -29/+250°C (-20/+482°F).	
Operation	Spring return.	
Connections	1/2" - 150lbs RF ANSI B16.5.	
Please note:	the above is a basic specification only. DOPAK® Samplers can be offered with a wide variety of options as mentioned below.	

5 OPTIONS

- Heating jacket for valve and needle assembly
- Continuous needle purge
- Exotic materials
- Larger/smaller sample size

For more information please refer to our sheets:

Options for DOPAK® process samplers, sampling into a bottle.

Components for DOPAK® process samplers.

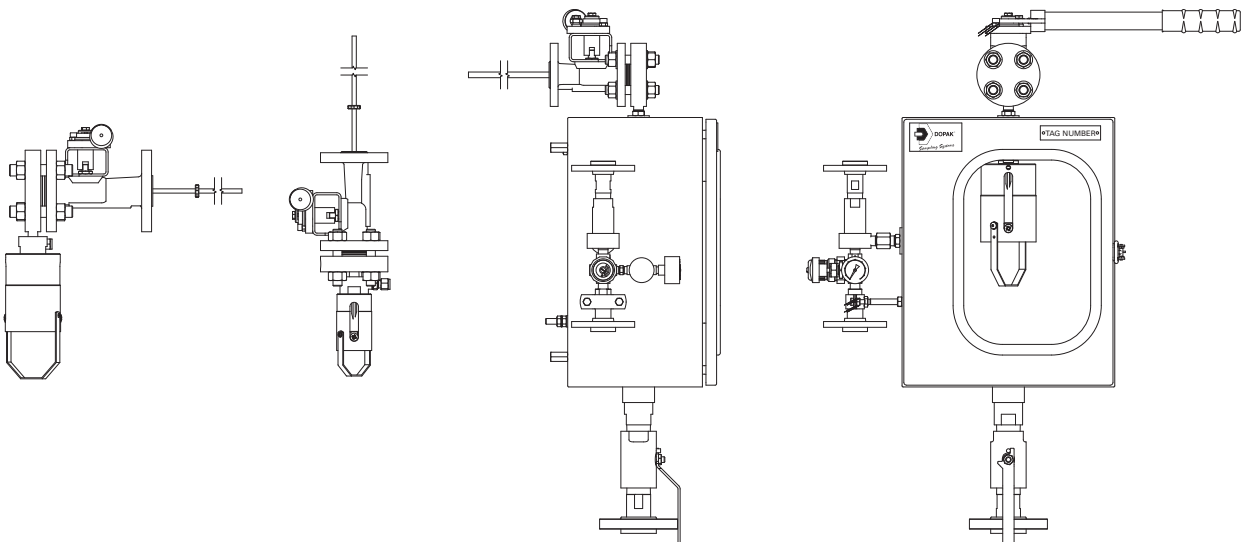

Dopak Inc.

Houston, Texas 77041, USA
 Phone 713-460-8311
 Fax 713-460-8578
 E-mail info@dopak.com

Dovianus BV

Bergschenhoek, The Netherlands
 Phone +31 10 524 20 00
 Fax +31 10 524 20 29
 E-mail info@dopak.nl

Your local representative:

